

Solu

# **HARDWARE**

Combining Design And Engineering Excellence



# Solu

## *Combining Design And Engineering Excellence*

Solu takes pride in Australian design and engineering excellence. We develop products which intergrate beautifully with the simplicity of contemporary home and office design. We are currently developing new designs which will continue to focus on elegant design with a strong use of metals.

Solu offers a range of metal legs and handles which integrate beautifully with the simplicity of contemporary home and office design. Set against the warmth of wood, glass reflections or colourful polyurethane surfaces, Solu will add to the finish of your furniture. Solu legs are engineered with a high load capacity and of course are also height adjustable.



## HANDLE FREE SOLUTIONS-*Shadowline*

A handle free solution with a dual purpose. Developed by Solu, a handle free solution that can be used as a support rail for cabinets. The patented Shadowline System is designed by Australians for the Australian Market and comes in 2 different sizes: (i) 42mm and (ii) 52mm.

The 42mm can be used under benchtops and was designed to replace your fixing rail and could easily fit over the top of your dishwasher with little (or no adjustment) to your cabinets, It is also small enough not to take up too much storage space in your cabinet and drawers.

The 52mm can be used between drawers and is designed so you can use one shadowline between two drawers and still have enough space to put your fingers in behind the drawer front to open them.

Introduced for 2020, the Solu Shadowline range now includes the new L-shape profile and provides the same level of quality the Solu Shadowline has always delivered. Utilising Solu's unique patented clip system, all Shadowline profiles are available in six finishes:

- Clear Anodised
- Silver Brushed
- Nickel Brushed
- White Powdercoat
- Black Powdercoat
- Black Brushed





HANDLE FREE SOLUTIONS-*Finger Recess*

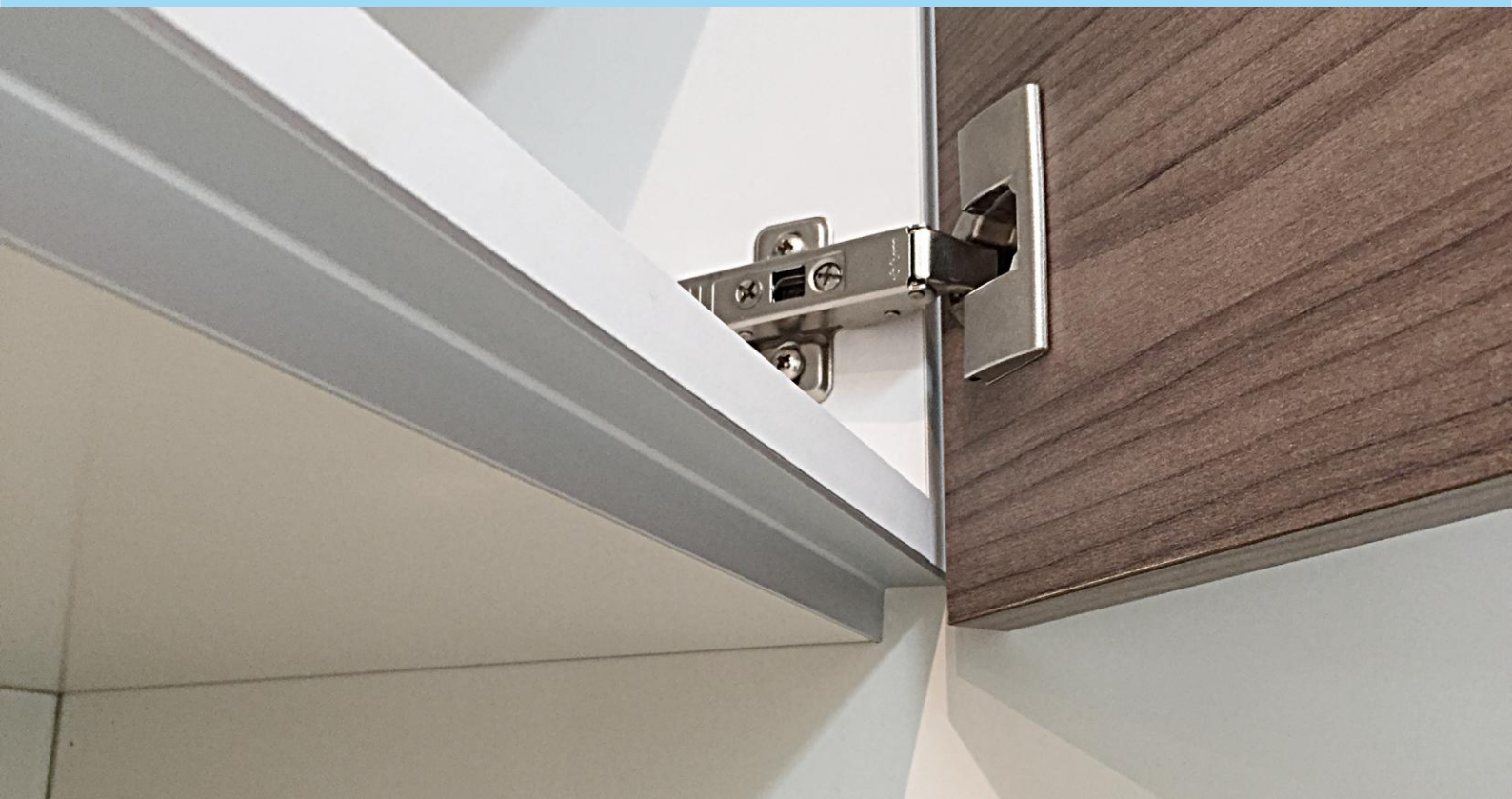



## PROFILE HANDLE SOLUTIONS







## FLOATING SOLUTIONS





## ADJUSTABLE LEGS & HANDLES







## Shadowline Handle

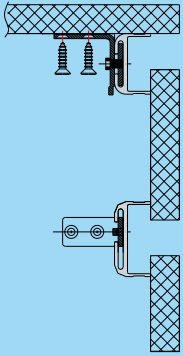

silver brushed anodized

nickel brushed anodized

black brushed anodized

clear anodized



white powder coated

black powder coated

antique gold anodized  
(hand-polished)

### 42mm Shadowline Notch Details:

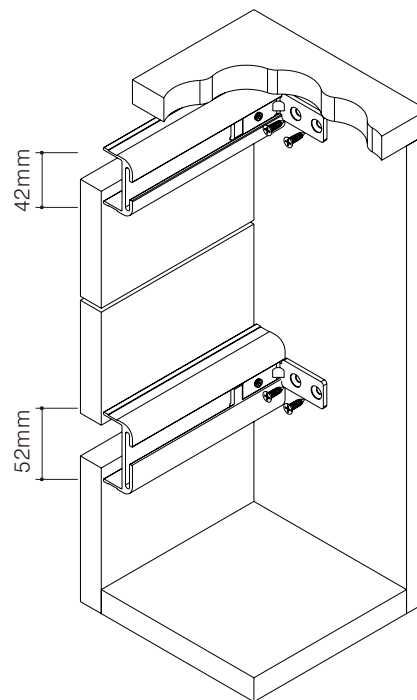
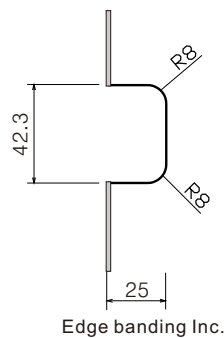
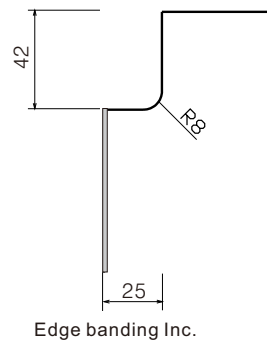

Cat.No	Length (mm)	Finish
2110.38.042	3700*	clear anodized
2110.37.042	3700*	silver brushed anodized
2110.36.042	3700*	black brushed anodized
2110.35.042	3700*	nickel brushed anodized
2110.34.042	3700*	antique gold anodized
2110.31.042	3700*	white powder coated
2110.30.042	3700*	black powder coated

Packing : 4pcs

\* Usable length 3630~3670mm

# Shadowline Handle



silver brushed anodized    nickel brushed anodized    black brushed anodized    clear anodized



white powder coated    black powder coated    antique gold anodized (hand-polished)

## 52mm Shadowline Notch Details:

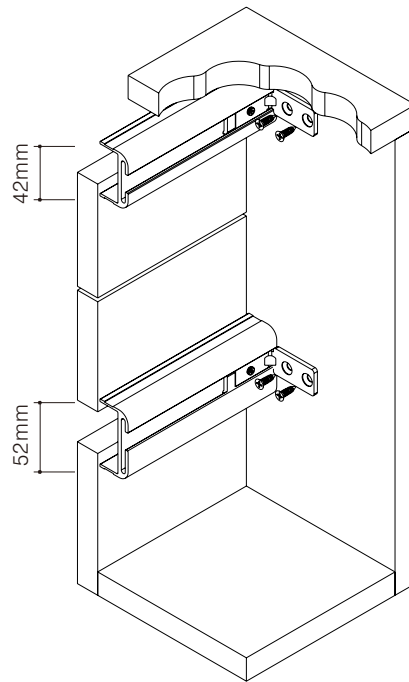
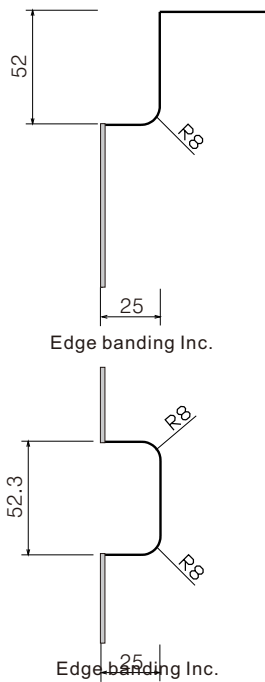

Cat.No	Length (mm)	Finish
2110.38.052	3700*	clear anodized
2110.37.052	3700*	silver brushed anodized
2110.36.052	3700*	black brushed anodized
2110.35.052	3700*	nickel brushed anodized
2110.34.052	3700*	antique gold anodized
2110.31.052	3700*	white powder coated
2110.30.052	3700*	black powder coated

Packing: 4pcs

\*Usable length 3630~3670mm

Solu

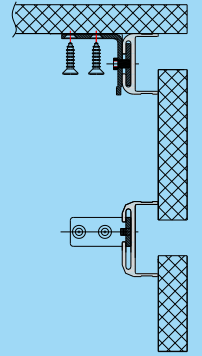

HANDLE-FREE SOLUTIONS

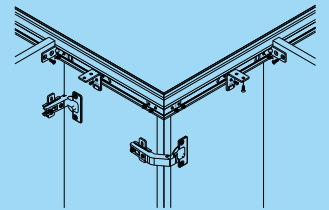

Dimensional Data not binding.  
We reserve the right to alter specifications without notice.

## Shadowline End Caps



**nickel-plated, matt**  
suitable for shadowline finish:  
nickel brushed anodized

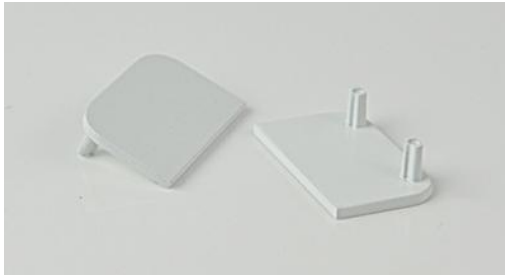

**white, powder coated**  
suitable for shadowline finish:  
white powder coated



**chrome-plated, matt**  
suitable for shadowline finish:  
clear anodized & silver brushed anodized



**black powder coated**  
suitable for shadowline finish:  
black brushed anodized & black powder coated

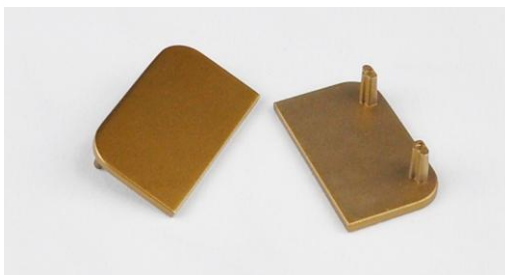

**gold, powder coated**  
suitable for shadowline finish:  
antique gold anodized

### 42mm End Cap

zinc alloy;

Cat No ■	Finish
2110.45.042	nickel-plated, matt
2110.44.042	gold, powder coated
2110.43.042	chrome-plated, matt
2110.41.042	white, powder coated
2110.40.042	black, powder coated

Packing: 100Pcs per carton

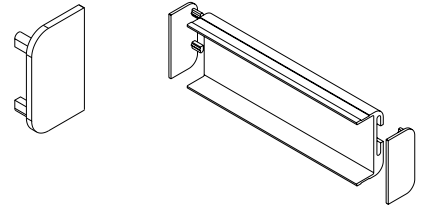

Suitable for 42mm shadowlines

Cat No ■	Finish
2110.43.142	satin chrome plated

Packing: 100Pcs per carton

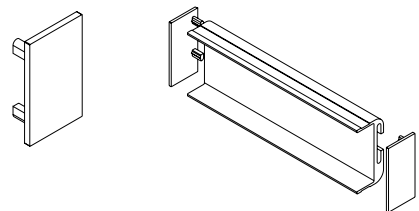

Suitable for 42mm shadowlines

### 52mm End Cap

zinc alloy;

Cat No ■	Finish
2110.45.052	nickel-plated, matt
2110.44.052	gold, powder coated
2110.43.052	chrome-plated, matt
2110.41.052	white, powder coated
2110.40.052	black, powder coated

Packing: 50pairs per carton

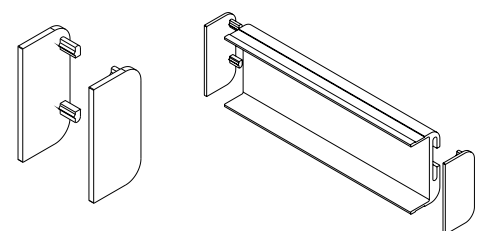

Suitable for 52mm shadowlines

Dimensional Data not binding.  
We reserve the right to alter  
specifications without notice.



# Shadowline Handle



silver brushed anodized



nickel brushed anodized



black brushed anodized



Clear anodized



white powder coated



black powder coated

## 42mm Shadowline L shape Notch Details:

Cat No.	Length (mm)	Finish
2120. 38. 042	3700*	clear anodized
2120. 37. 042	3700*	silver brushed anodized
2120. 36. 042	3700*	black brushed anodized
2120. 35. 042	3700*	nickel brushed anodized
2120. 31. 042	3700*	white powder coated
2120. 30. 042	3700*	black powder coated

Packing: 4pcs

\* Usable length 3630~3670mm

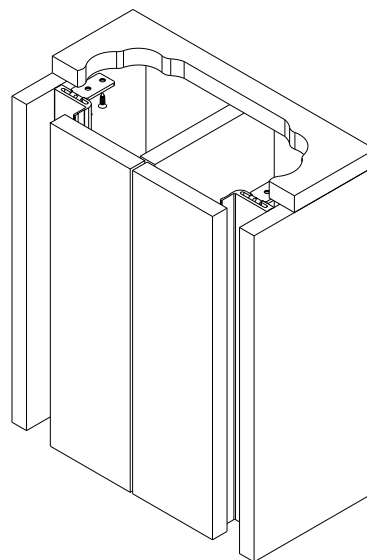
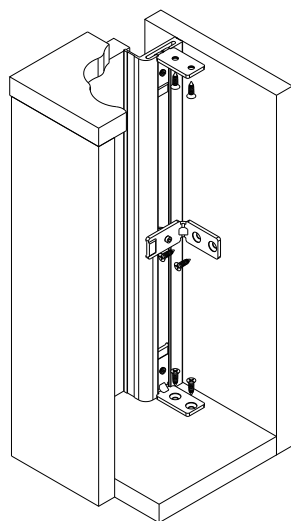
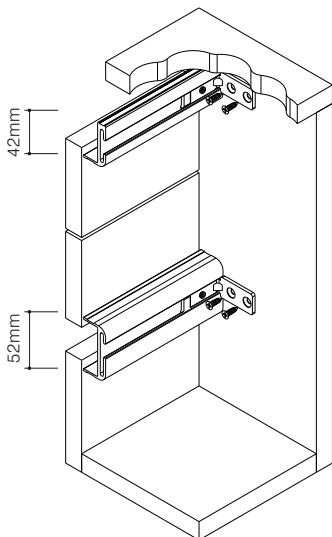
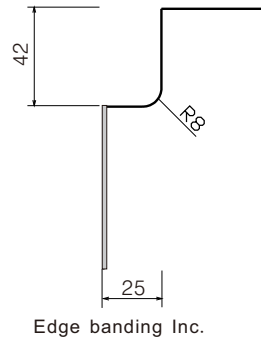

Solu

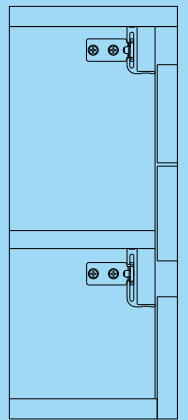
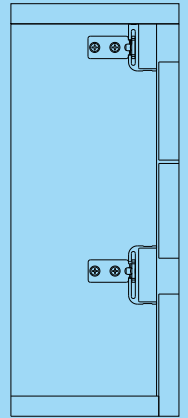

HANDLE FREE SOLUTIONS

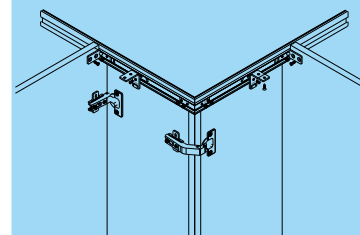

Dimensional Data not binding.  
We reserve the right to alter specifications without notice.

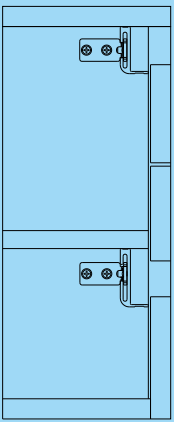
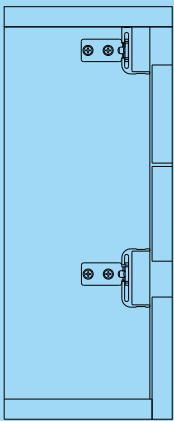

## Shadowline Handle



silver brushed anodized

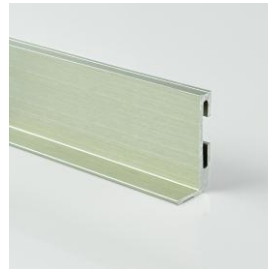

nickel brushed anodized



black brushed anodized



Clear anodized



white powder coated



black powder coated

### 42mm Shadowline L shape Notch Details:

Cat No.	Length (mm)	Finish
2120.38.052	3700*	clear anodized
2120.37.052	3700*	silver brushed anodized
2120.36.052	3700*	black brushed anodized
2120.35.052	3700*	nickel brushed anodized
2120.31.052	3700*	white powder coated
2120.30.052	3700*	black powder coated

Packing: 4pcs

\* Usable length 3630~3670mm

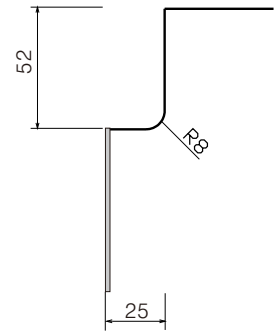

Edge banding Inc.

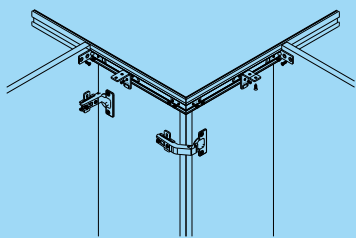
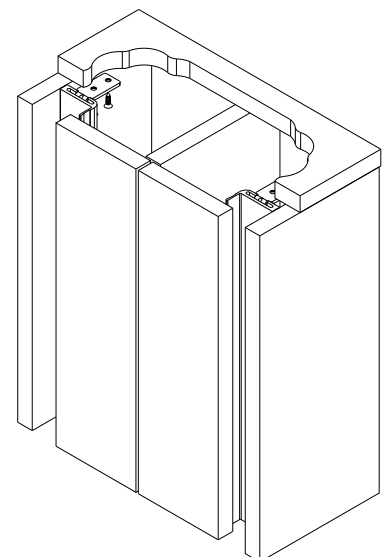
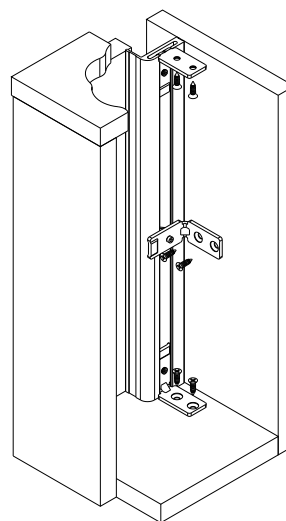
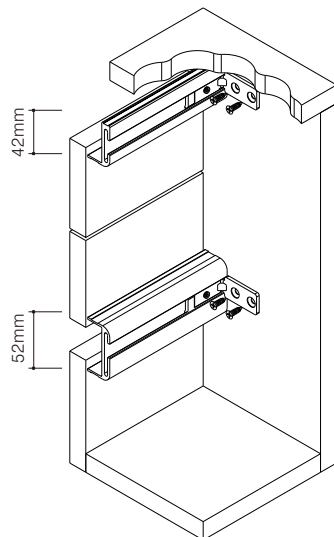

Dimensional Data not binding.  
We reserve the right to alter specifications without notice.

## Shadowline L Shape End Caps



### **matt nickel**

suitable for shadowline finish:  
nickel brushed anodized



### **satin chrome**

suitable for shadowline finish:  
clear anodized & silver brushed anodized



### **white powder coated**

suitable for shadowline finish:  
white powder coated



### **black powder coated**

suitable for shadowline finish:  
black brushed anodized & black powder coated

## 42mm End Cap

**zinc alloy ;**

Cat No.	Finish
2120. 45. 042	matt nickel
2120. 43. 042	satin chrome
2120. 41. 042	white powder coated
2120. 40. 042	black powder coated

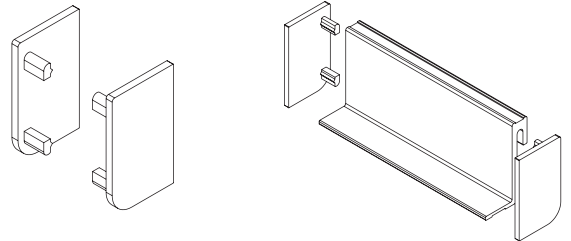

Packing: 50pairs per carton

## 52mm End Cap

**zinc alloy ;**

Cat No.	Finish
2120. 45. 052	matt nickel
2120. 43. 052	satin chrome
2120. 41. 052	white powder coated
2120. 40. 052	black powder coated

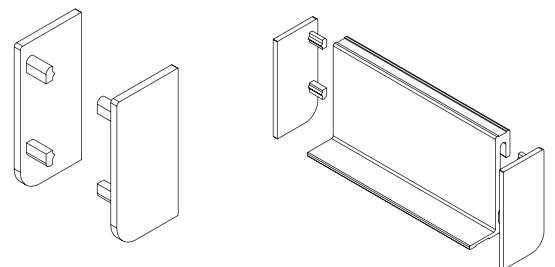

Packing: 50pairs per carton

Dimensional Data not binding.  
We reserve the right to alter  
specifications without notice.



# Shadowline Clips

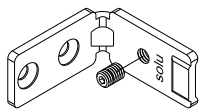

## End Clip

steel, zinc-plated

Cat No ■	2110.57.001
----------	-------------

Packing: 100Pcs per carton

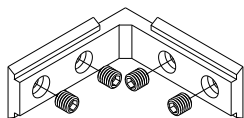

## External Corner Clip

zinc alloy, chrome-plated

Cat No ■	2110.43.004
----------	-------------

Packing: 50Pcs per carton

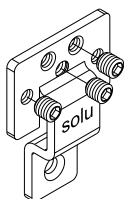

## Middle Clip

steel, zinc-plated

Cat No ■	2110.57.005
----------	-------------

Packing: 50Pcs per carton

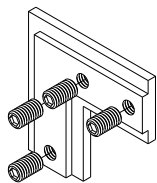

## Picture Frame Clip

zinc alloy, zinc-plated

Cat No ■	2110.43.006
----------	-------------

Packing: 50Pcs per carton

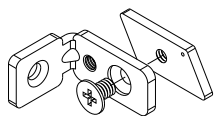

## Side Clip

steel, zinc-plated

Cat No ■	2110.57.009
----------	-------------

Packing: 100Pcs per carton

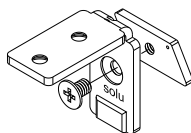

## Top Clip

steel, zinc-plated

Cat No ■	2110.57.002
----------	-------------

Packing: 100Pcs per carton

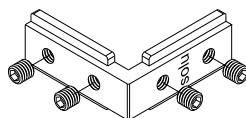

## Internal Corner Clip

zinc alloy, chrome-plated

Cat No ■	2110.43.003
----------	-------------

Packing: 50Pcs per carton

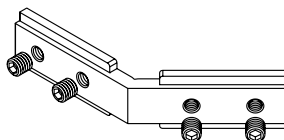

## Internal Corner Clip 135°

zinc alloy, chrome-plated

Cat No ■	2110.43.011
----------	-------------

Packing: 50Pcs per carton

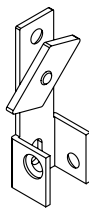

## Saddle Bracket

steel, zinc-plated

Cat No ■	2110.57.010
----------	-------------

Packing: 50Pcs per carton

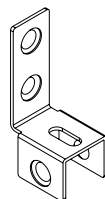

## Vanity Partition Bracket

steel, zinc-plated

Cat No ■	2110.57.007
----------	-------------

Packing: 100Pcs per carton

Solu

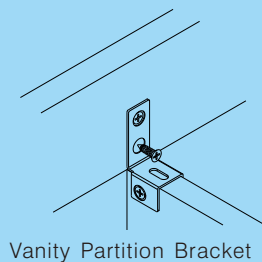
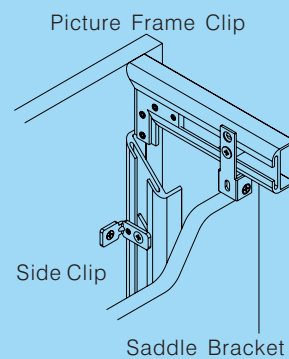
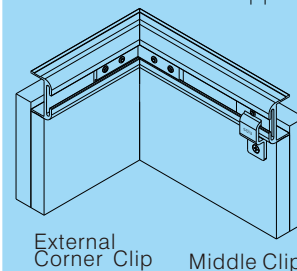
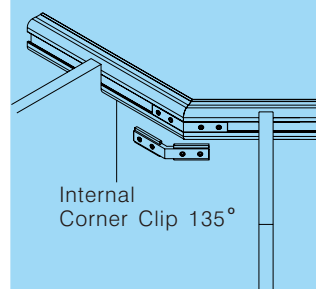
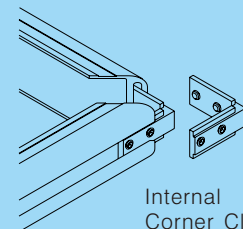
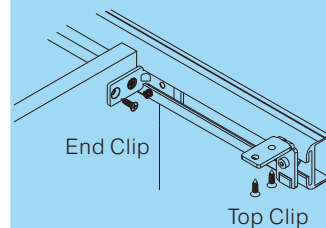

HANDLE-FREE SOLUTIONS

Dimensional Data not binding.  
We reserve the right to alter specifications without notice.

## Aluminium 2 1 Rail

### Aluminium 2 1 Rail

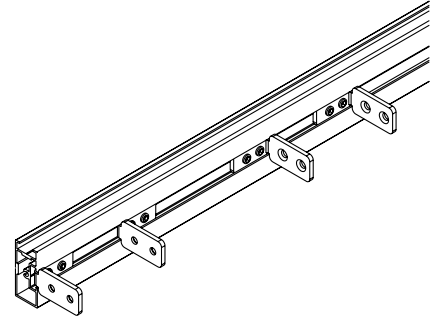
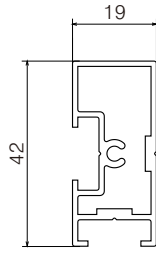
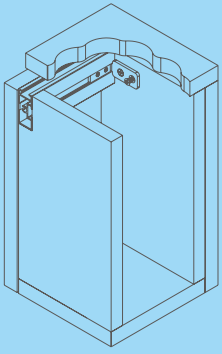

Cat No ■	Length (mm)	Finish
2380 ■ 31 ■ 042	3700*	white, powder coated
2380 ■ 38 ■ 042	3700*	clear anodized
2380 ■ 39 ■ 042	3700*	black anodized

Packing: 6pcs

\* Usable length 3630~3670mm

### Fixing Method

#### Flat

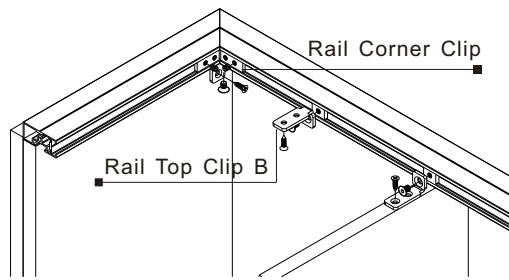

#### Inverted

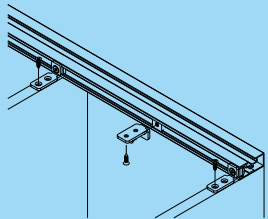
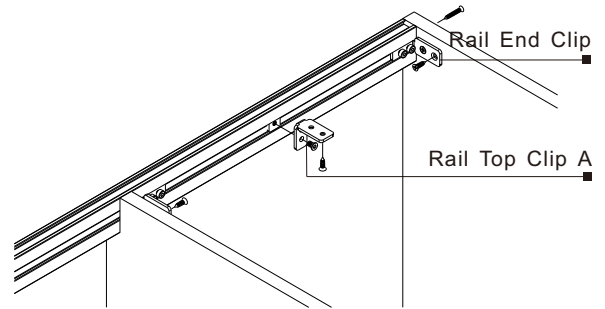

Dimensional Data not binding.  
We reserve the right to alter specifications without notice.

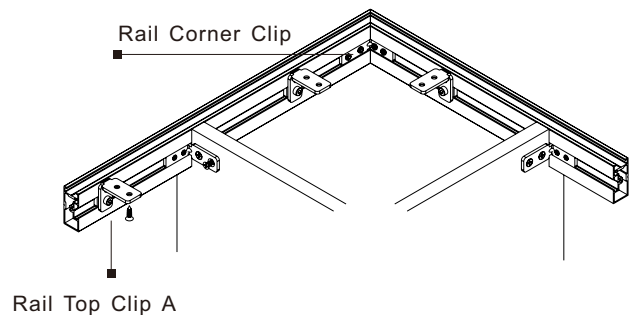

# Aluminium 2 1 Rail Clips

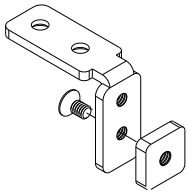

**Rail Top Clip A**

steel, zinc-plated

Cat No ■	2380.57.001
----------	-------------

Packing: 100Pcs per carton

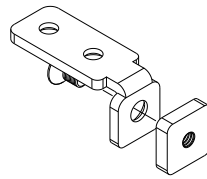

**Rail Top Clip B**

steel, zinc-plated

Cat No ■	2380.57.002
----------	-------------

Packing: 100Pcs per carton

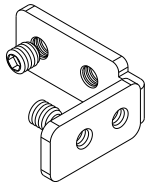

**Rail Corner Clip**

steel, zinc-plated

Cat No ■	2380.57.003
----------	-------------

Packing: 100Pcs per carton

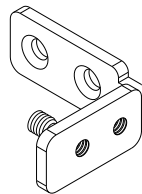

**Rail End Clip**

steel, zinc-plated

Cat No ■	2380.57.004
----------	-------------

Packing: 100Pcs per carton

# Aluminium 2 1 Rail End Caps

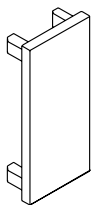

zinc alloy;

Cat No ■	Finish
2380.47.042	black plated
2380.41.042	white, powder coated
2380.43.042	chrome-plated, matt

Packing: 100Pcs per carton

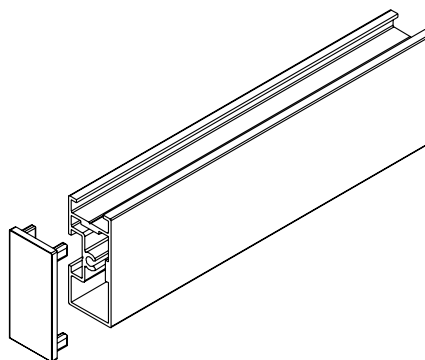

Dimensional Data not binding.  
We reserve the right to alter specifications without notice.



## Cabinet Finger Recess

### Router Bit

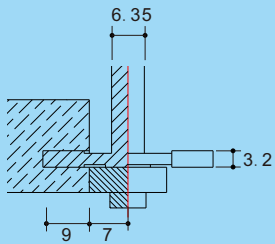
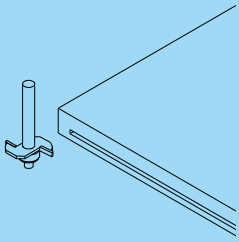

3.2mm slot bit 1/4"Shank  
32mm diameter with bearing

Cat No 0140.15.032

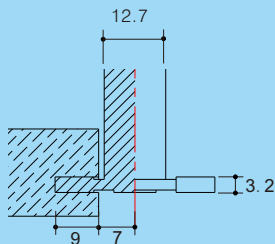

3.2mm slot bit 1/2"Shank  
32mm diameter no bearing  
for CNC

Cat No 0141.00.032

### 16mm Cabinet Finger Recess

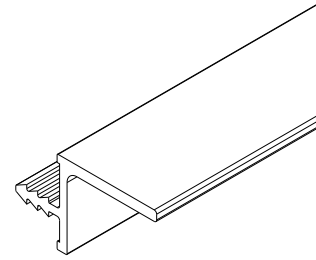
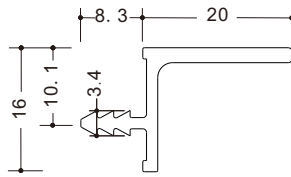

Cat No ■	Length (mm) / Finish
2115.31.016	2500*/white powder coated
2115.38.016	2500*/clear anodized
2115.39.016	2500*/black anodized

Packing: 16Pcs per carton



White powder coated

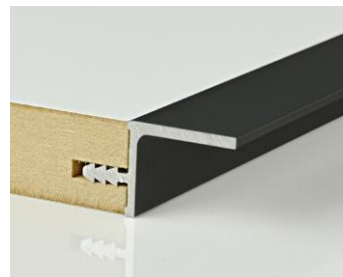

Black anodized



Clear anodized

### 18mm Cabinet Finger Recess

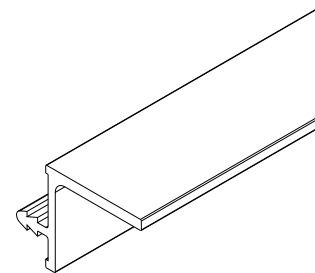
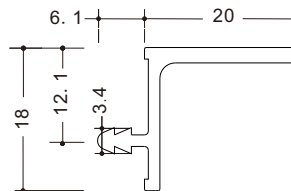

Cat No ■	Length (mm) / Finish
2115.31.018	2500*/white powder coated
2115.38.018	2500*/clear anodized
2115.39.018	2500*/black anodized

Packing: 16Pcs per carton



White powder coated



Black anodized



Clear anodized

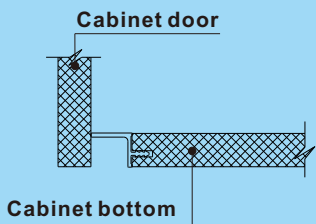

Dimensional Data not binding.  
We reserve the right to alter  
specifications without notice.

# Profile Handles

## Slimline U shape

aluminium, anodized

Cat No ■	Length (mm)	Finish
2468.39.007	2500*	black
2468.38.007	2500*	clear

Packing: 30Pcs per carton

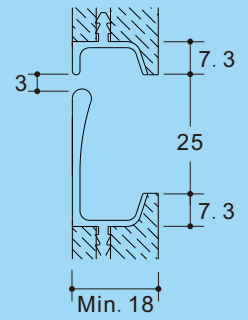
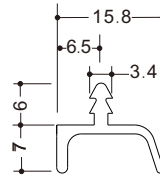
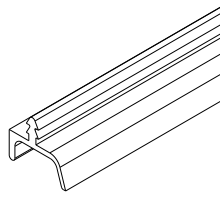

## Slimline L shape

aluminium, anodized

Cat No ■	Length (mm)	Finish
2468.39.029	2500*	black
2468.38.029	2500*	clear

Packing: 20Pcs per carton

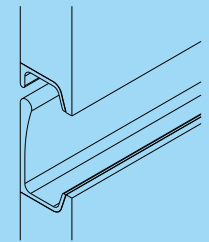
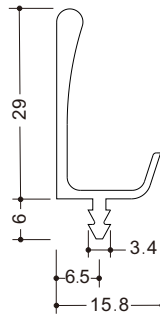
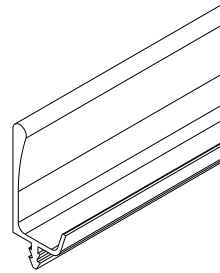

## Slimline C shape

aluminium, anodized

Cat No ■	Length (mm)	Finish
2468.39.039	2500*	black
2468.38.039	2500*	clear

Packing: 10Pcs per carton

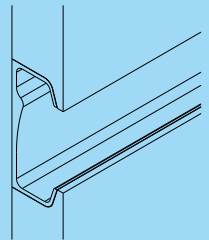
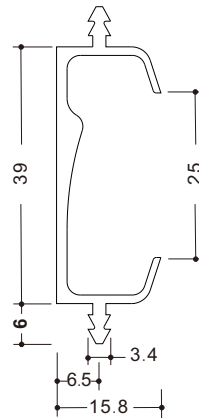
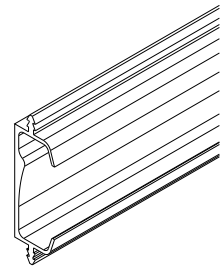

## Router Bit

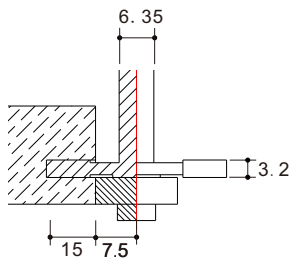

3. 2mm slot bit 1/4"Shank 45mm diameter with bearing

Cat No ■	0140.15.045
----------	-------------

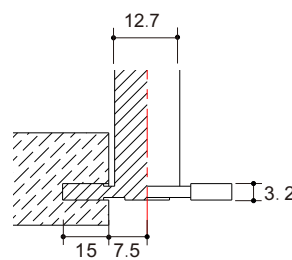

3. 2mm slot bit 1/2"Shank 45mm diameter no bearing for CNC

Cat No ■	0141.00.045
----------	-------------

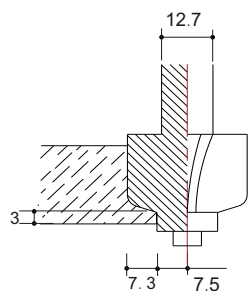

Slimline bit 1/2"Shank with bearing

Cat No ■	0151.15.029
----------	-------------

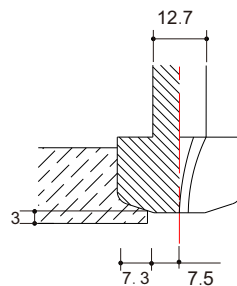

Slimline bit 1/2"Shank no bearing for CNC

Cat No ■	0151.00.029
----------	-------------

\* Usable length 2430~2470mm

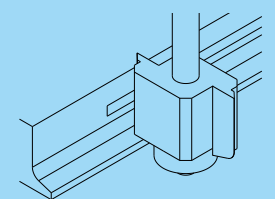
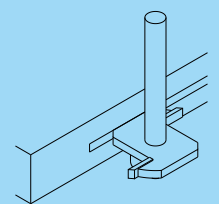

Dimensional Data not binding.  
We reserve the right to alter specifications without notice.

## Profile Handles

### Thinline U shape mounted with screws

aluminium, anodized

Cat No ■	Length (mm)	Finish
2469.39.008	2500*	black anodized
2469.38.008	2500*	clear anodized

Packing: 20Pcs per carton

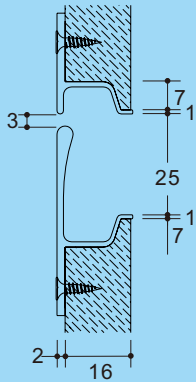
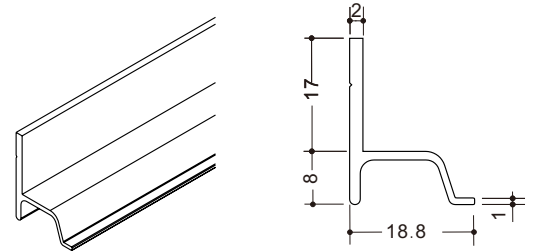

16mm Board

### Thinline L shape mounted with screws

aluminium, anodized

Cat No ■	Length (mm)	Finish
2469.39.029	2500*	black anodized
2469.38.029	2500*	clear anodized

Packing: 20Pcs per carton

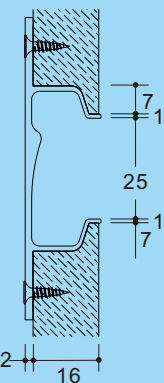
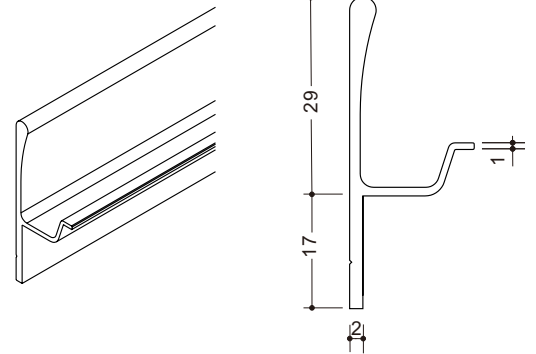

16mm Board

### Thinline C shape mounted with screws

aluminium, anodized

Cat No ■	Length (mm)	Finish
2469.39.041	2500*	black anodized
2469.38.041	2500*	clear anodized

Packing: 10Pcs per carton

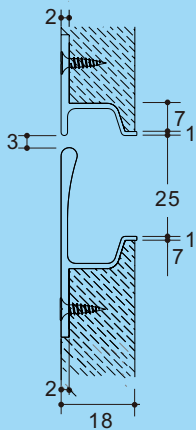
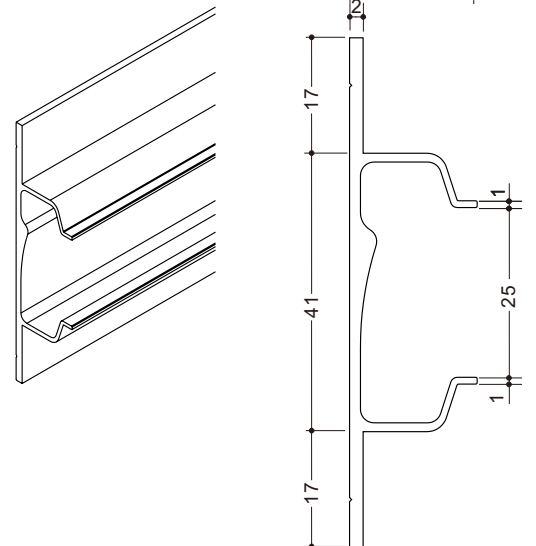

18mm Board

### Router Bit

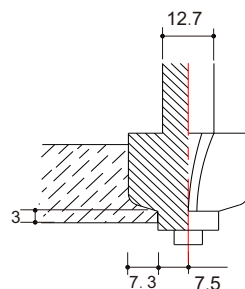

Slimline bit 1/2"Shank with bearing

Cat No ■	0151.15.029
----------	-------------

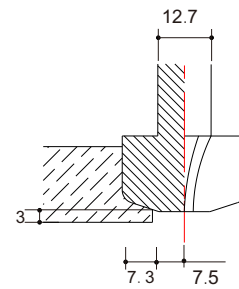

Slimline bit 1/2"Shank no bearing for CNC

Cat No ■	0151.00.029
----------	-------------

\* Usable length 2430~2470mm

Dimensional Data not binding.  
We reserve the right to alter specifications without notice.

# Profile Handles

## Boldline U shape

aluminium, anodized

Cat No ■	Length (mm)	Finish
2460.39.010	2500*	black
2460.38.010	2500*	clear

Packing: 20Pcs per carton

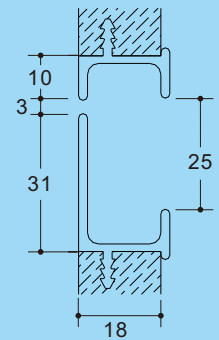
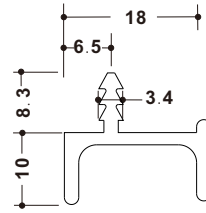
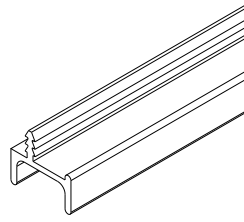

## Boldline L shape

aluminium, anodized

Cat No ■	Length (mm)	Finish
2460.39.031	2500*	black
2460.38.031	2500*	clear

Packing: 20Pcs per carton

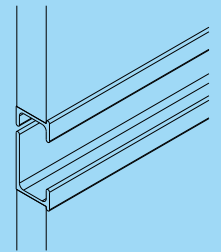
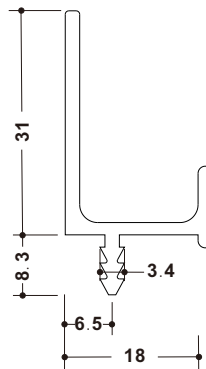
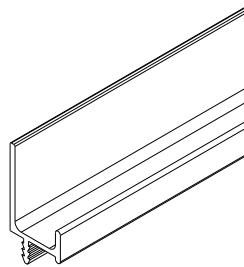

## Boldline C shape

aluminium, anodized

Cat No ■	Length (mm)	Finish
2460.39.044	2500*	black
2460.38.044	2500*	clear

Packing: 10Pcs per carton

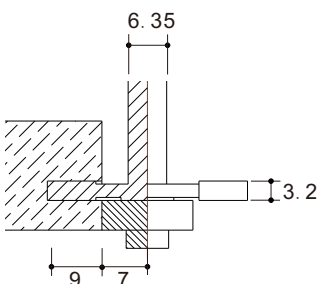
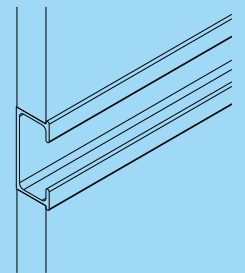
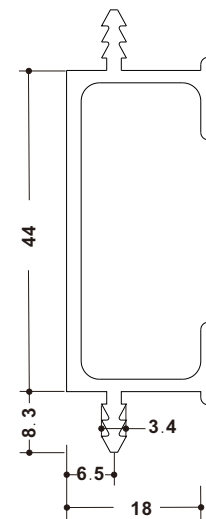
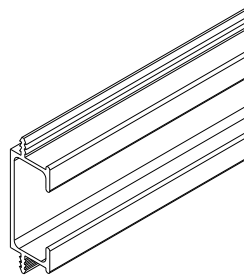

### Router Bit

3.2mm slot bit 1/4" Shank  
32mm diameter with bearing

Cat No ■	0140.15.032
----------	-------------

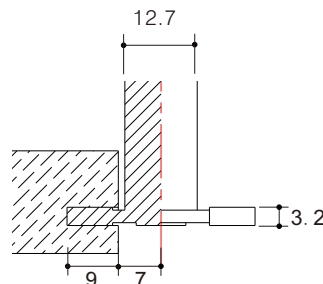

### Router Bit

3.2mm slot bit 1/2" Shank  
32mm diameter no bearing for CNC

Cat No ■	0141.00.032
----------	-------------

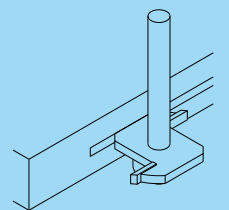

Dimensional Data not binding.  
We reserve the right to alter specifications without notice.

\* Usable length 2430~2470mm



## Profile Handles

16mm Board

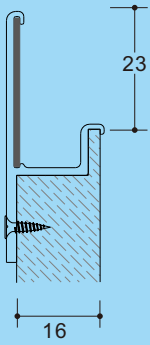

### Lamiline L shape mounted with screws

aluminium, anodized

Cat No ■	Length (mm)	Finish
2462.39.032	2500*	black anodized
2462.38.032	2500*	clear anodized

Packing: 20Pcs per carton

\* Recommended laminate strip width: 29mm

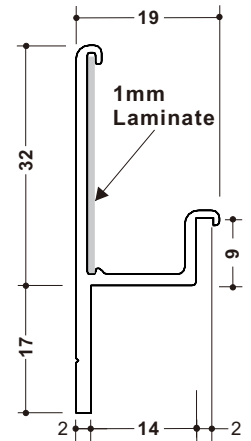
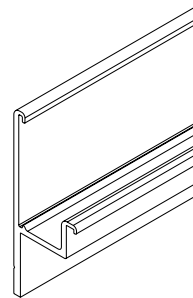

18mm Board

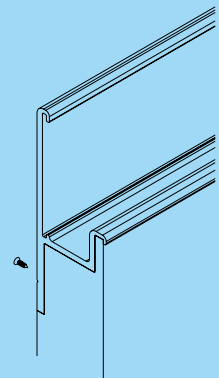
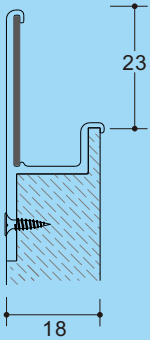

Dimensional Data not binding.  
We reserve the right to alter specifications without notice.

# Profile Handles

## Broadline G shape for 18mm board

aluminium, anodized

Cat No ■	Length (mm)	Finish
2463.39.018	2500*	black
2463.38.018	2500*	clear

Packing: 6Pcs per carton

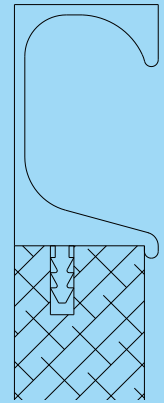
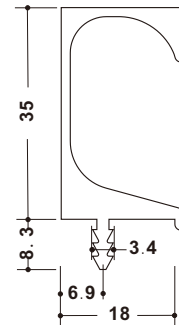
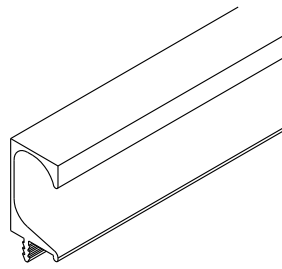

## Broadline G shape for 16mm board

aluminium, anodized

Cat No ■	Length (mm)	Finish
2472.39.016	2500*	black
2472.38.016	2500*	clear

Packing: 6Pcs per carton

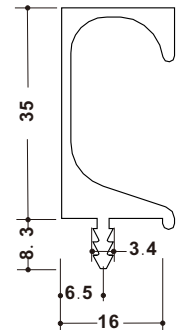
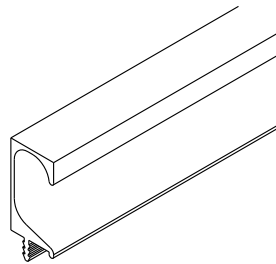

## Broadline G shape for 16mm board, mounted with screws

aluminium, anodized

Cat No ■	Length (mm)	Finish
2474.39.016	2500*	black
2474.38.016	2500*	clear

Packing: 10Pcs per carton

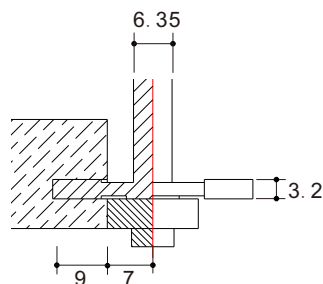
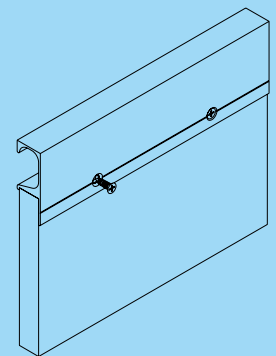
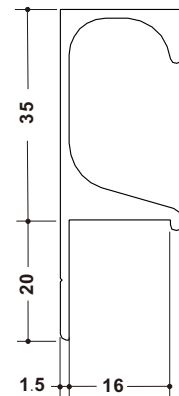
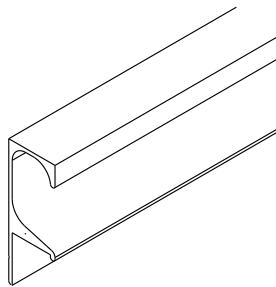

### Router Bit

3.2mm slot bit 1/4"Shank  
32mm diameter with bearing

Cat No ■	0140.15.032
----------	-------------

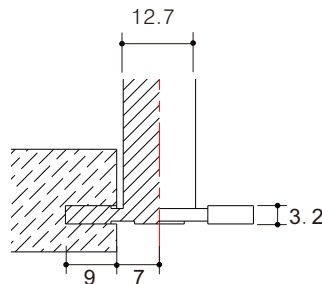

### Router Bit

3.2mm slot bit 1/2"Shank  
32mm diameter no bearing for CNC

Cat No ■	0141.00.032
----------	-------------

\* Usable length 2430~2470mm

Dimensional Data not binding.  
We reserve the right to alter specifications without notice.

# Recessed Handle

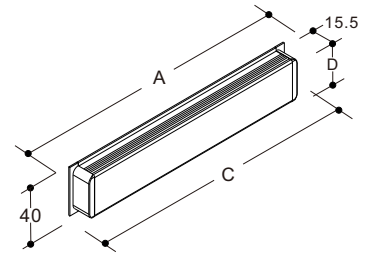

**Handle profile: clear, anodized**  
**End cap: zinc alloy, satin chrome**

Cat No.	Size A	D	Size C
3411.38.190	189	36	183

## Extrusion Handle Profile

**aluminium, clear, anodised**

Cat No. ■	Length
3411.38.001	2500*

\* Usable length 2430~2470mm

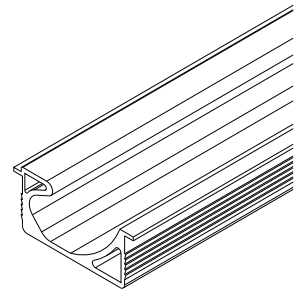

## End Cap

**zinc alloy, chrome-plated, matt**

Cat No. ■	3411.43.002
-----------	-------------

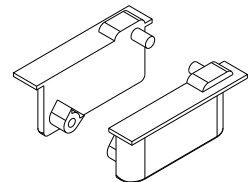

Dimensional Data not binding.  
 We reserve the right to alter specifications without notice.

# Floating Shelf Supports



## Application Specs and Features:

- shelf thickness: 50mm Recommended
- shelf depth: 250-300mm Recommended.
- Load capacity: 12.5 kg/ Arm evenly distributed load across arm length)

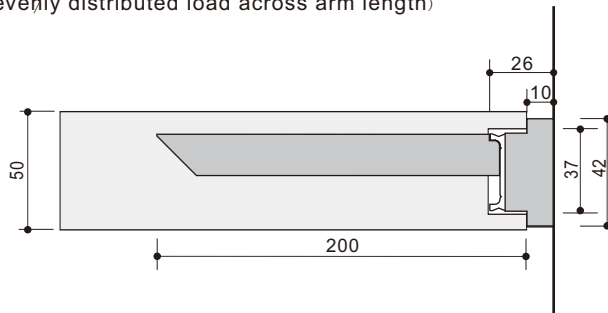
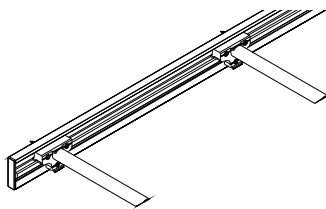

### Track

aluminium, clear, anodised

Cat No ■	Length (mm)
8160 ■ 38 ■ 042	2500*

### Arm Block

Zinc alloy: nickel plated; Stainless steel, matt brush.

Cat No ■	Unit
8160 ■ 37 ■ 190	pcs

### Track End Cap

Zinc alloy: chrome-plated, matt.

Cat No ■	Unit
8160 ■ 43 ■ 001	pair

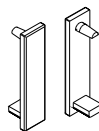
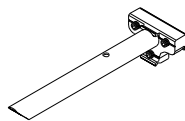
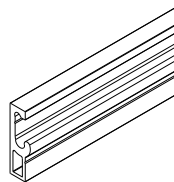

step 1

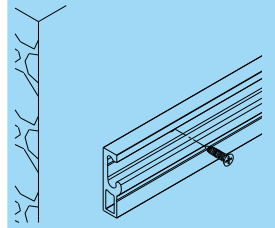

step 2

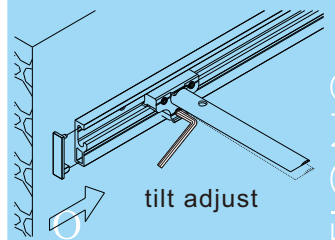

4

step 3

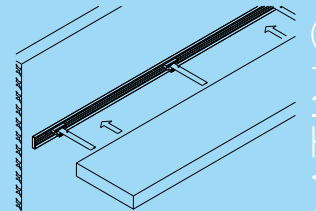

FLOATING SOLUTIONS

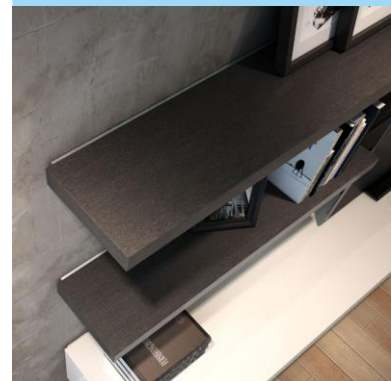

Dimensional Data not binding.  
We reserve the right to alter specifications without notice.

\* Usable length 2430~2470mm



## Floating Cabinet Supporter Kit



### FC supporter

aluminium, clear, anodised

Cat No.	Length (mm)
8160.38.050	4200*

Packing: 1set

Load capacity: Max: 50kg/M

Note: Additional clips and cap can be ordered separately.

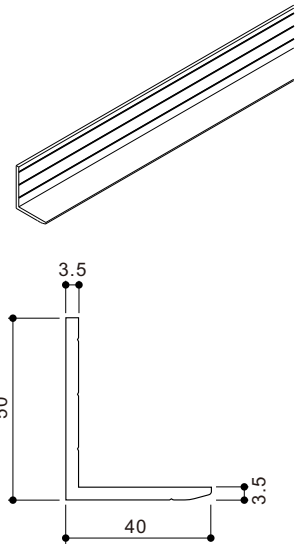

### Fixing Method



Aluminium 2 1 Rail

2381.38.360

Page:1.05

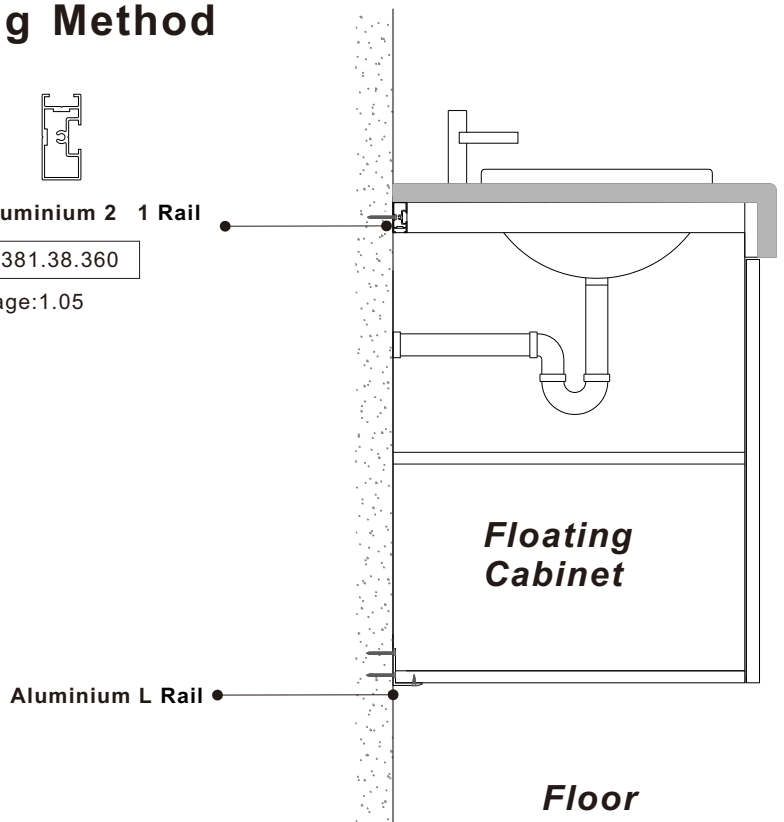

Dimensional Data not binding.  
We reserve the right to alter specifications without notice.

# Cabinet Legs

## Adjustable Leg

Fixing plate: zinc alloy, chrome-plated  
 Tube: stainless steel  
 Glide: plastic, black

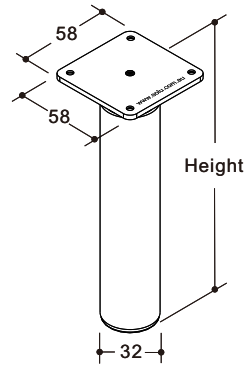

Cat No.		Height	Adjustable Range
matt brushed	mirror polished		
1120.22.080	1120.25.080	80	-5 +10
1120.22.100	1120.25.100	100	-5 +10
1120.22.120	1120.25.120	120	-5 +10
1120.22.150	1120.25.150	150	-5 +10
1120.22.200	1120.25.200	200	-5 +10
1120.22.250	1120.25.250	250	-5 +10
1120.22.300	1120.25.300	300	-5 +10

Packing: 1 and 20 pieces

## Adjustable Leg

Fixing plate: zinc alloy, chrome-plated  
 Tube: stainless steel  
 Glide: plastic, black

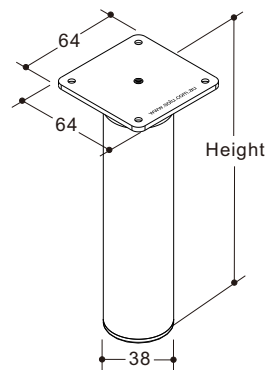

Cat No.		Height	Adjustable Range
matt brushed	mirror polished		
1121.22.080	1121.25.080	80	-5 +10
1121.22.100	1121.25.100	100	-5 +10
1121.22.120	1121.25.120	120	-5 +10
1121.22.150	1121.25.150	150	-5 +10
1121.22.200	1121.25.200	200	-5 +10
1121.22.250	1121.25.250	250	-5 +10
1121.22.300	1121.25.300	300	-5 +10

Packing: 1 and 20 pieces

Dimensional Data not binding.  
 We reserve the right to alter specifications without notice.

# Cabinet Legs

## Adjustable Leg

Fixing plate: zinc alloy,  
 Tube: aluminium, clear anodized  
 Glide: lastic, black

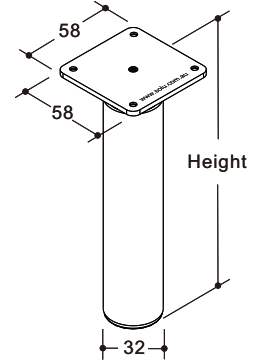

Cat No.	Height	Adjustable Range
1122.38.050	52	-5 +10
1122.38.080	80	-5 +10
1122.38.100	100	-5 +10
1122.38.120	120	-5 +10
1122.38.150	150	-5 +10
1122.38.200	200	-5 +10
1122.38.300	300	-5 +10

Packing: 1 and 20 pieces

## Adjustable Leg

Fixing plate: zinc alloy,  
 Tube: aluminium, clear anodized  
 Glide: plastic, black

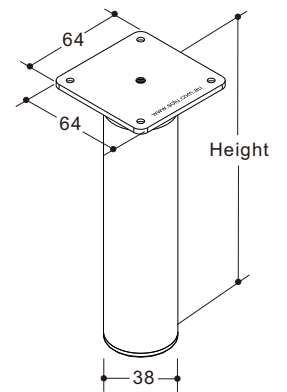

Cat No.	Height	Adjustable Range
1123.38.050	52	-5 +10
1123.38.080	80	-5 +10
1123.38.100	100	-5 +10
1123.38.120	120	-5 +10
1123.38.150	150	-5 +10
1123.38.200	200	-5 +10
1123.38.300	300	-5 +10

Packing: 1 and 20 pieces

Dimensional Data not binding.  
 We reserve the right to alter specifications without notice.

# Cabinet Legs

## Adjustable Leg

Fixing plate: zinc alloy,  
 Tube: aluminium, black anodized  
 Glide: lastic, black

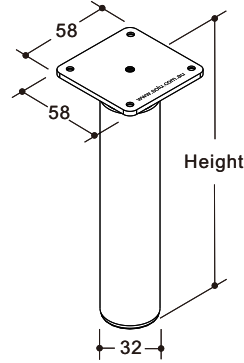

Cat No.	Height	Adjustable Range
1122.30.050	52	-5 +10
1122.30.080	80	-5 +10
1122.30.100	100	-5 +10
1120.30.120	120	-5 +10
1122.30.150	150	-5 +10

Packing: 1 and 20 pieces

## Adjustable Leg

Fixing plate: zinc alloy,  
 Tube: aluminium, black anodized  
 Glide: plastic, black

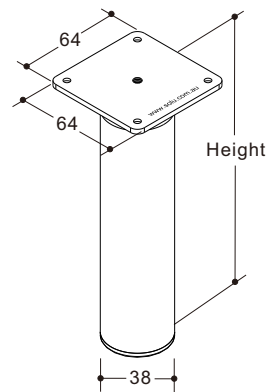

Cat No.	Height	Adjustable Range
1123.30.050	52	-5 +10
1123.30.080	80	-5 +10
1123.30.100	100	-5 +10
1123.30.120	120	-5 +10
1123.30.150	150	-5 +10

Packing: 1 and 20 pieces

Dimensional Data not binding.  
 We reserve the right to alter specifications without notice.



## Cabinet Legs



### Adjustable Leg

**Fixing plate:** zinc alloy, chrome-plated, matt  
**Tube:** aluminium, silver colour, anodized  
**Foot:** zinc alloy, satin chrome

Cat No.	Height	Adjustable Range
1124.38.080	80	-10 +10
1124.38.100	100	-10 +10
1124.38.120	120	-10 +10
1124.38.150	150	-10 +10
1124.38.200	200	-10 +10
1124.38.300	300	-10 +10
1124.38.720	720	-10 +10

Packing: 1 and 8 pieces

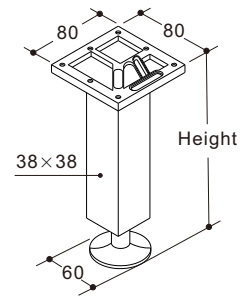

### Adjustable Leg

**Fixing plate:** zinc alloy, chrome-plated, matt  
**Tube:** aluminium, silver colour, anodized  
**Glide:** plastic, black

Cat No.	Height	Adjustable Range
1126.38.080	80	-10 +10
1126.38.100	100	-10 +10
1126.38.120	120	-10 +10
1126.38.150	150	-10 +10
1126.38.300	300	-10 +10

Packing: 1 and 20 pieces

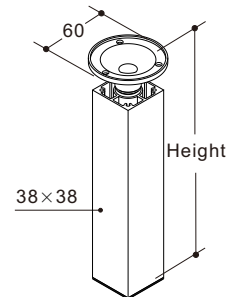

## Cabinet Legs

### Adjustable Leg

**Fixing plate:** zinc alloy, chrome-plated, matt  
**Tube:** aluminium, silver colour, anodized  
**Foot:** zinc alloy, satin chrome

Cat No.	Height	Adjustable Range
1125.38.120	120	-10 +10
1125.38.150	150	-10 +10

Packing: 1 and 20 pieces

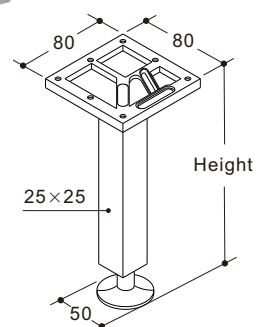

Dimensional Data not binding.  
 We reserve the right to alter specifications without notice.

# Aluminium Edge Profiles

Solu

## 3mm Wrapped Edge For 19mm board

aluminium anodized

Cat No ■	Length (mm)	Finish
4131.39.019	2500*	black
4131.38.019	2500*	clear
4131.38.019.30	3000	clear

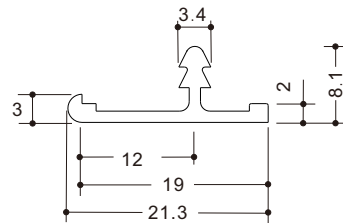
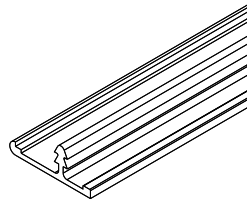

## 2mm Flush Edge For 19mm board

aluminium anodized

Cat No ■	Length (mm)	Finish
4268.39.019	2500*	black
4268.38.019	2500*	clear

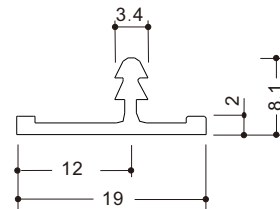
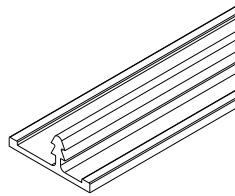

## 3mm Flush Edge For 25mm board

aluminium anodized

Cat No ■	Length (mm)	Finish
4268.39.025	3700*	black
4268.38.025	3700*	clear

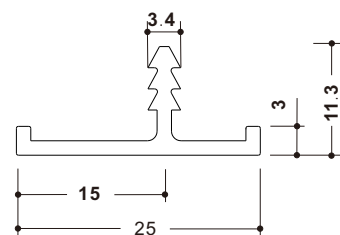
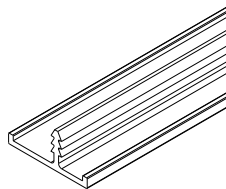

## 25mm Edge Corner

zinc alloy, plated

Cat No ■	R	Finish
4268.39.001	0	black
4268.43.002	0	satin chrome
4268.39.002	3	black
4268.43.002	3	satin chrome

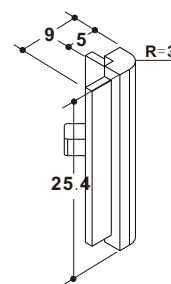
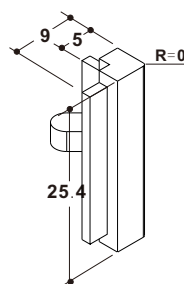

## Router Bit

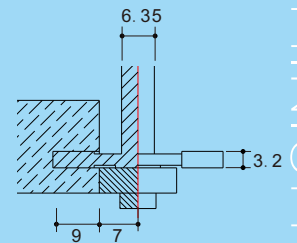
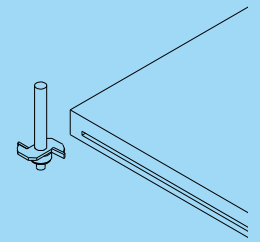

3. 2mm slot bit 1/4" Shank  
32mm diameter with bearing

Cat No ■ 0140.15.032

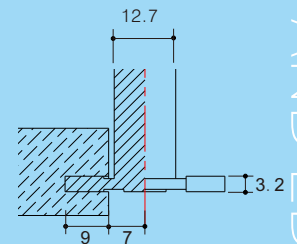

3. 2mm slot bit 1/2" Shank  
32mm diameter no bearing  
for CNC

Cat No ■ 0141.00.032

ALUMINIUM DOOR AND EDGE PROFILES

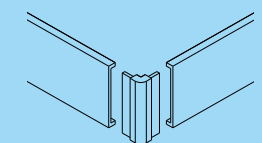

Dimensional Data not binding.  
We reserve the right to alter  
specifications without notice.

\* Usable length 2430~2470mm

\*\* Usable length 3630~3670mm

## Aluminium Edge Profiles

### Router Bit

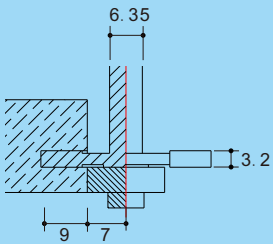
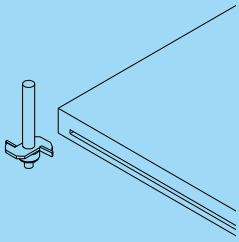

3.2mm slot bit 1/4"Shank  
32mm diameter with bearing

Cat No ■ 0140.15.032

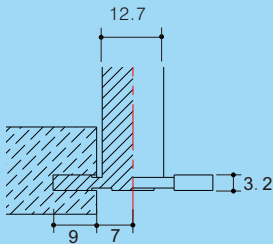

3.2mm slot bit 1/2"Shank  
32mm diameter no bearing  
for CNC

Cat No ■ 0141.00.032

### 3mm Wrapped Edge For 16mm board

aluminium anodized

Cat No ■	Length (mm)	Finish
4131.39.016	2500*	black
4131.38.016	2500*	clear
4131.38.016.30	3000	clear

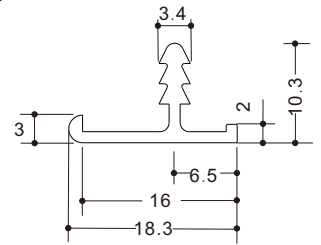
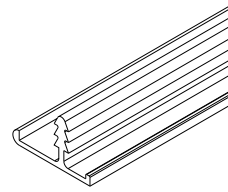

### 6mm Wrapped Edge For 16mm board

aluminium anodized

Cat No ■	Length (mm)	Finish
4132.39.016	2500*	black
4132.38.016	2500*	clear
4132.38.016.30	3000	clear

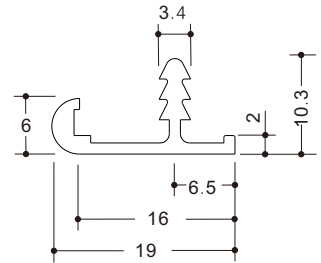
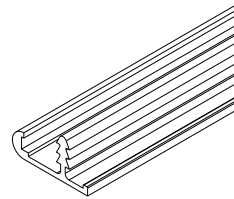

### 2mm Flush Edge For 16mm board

aluminium anodized

Cat No ■	Length (mm)	Finish
4268.39.016	2500*	black
4268.38.016	2500*	clear

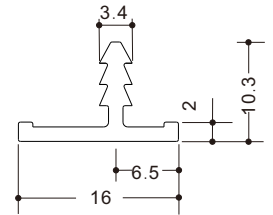
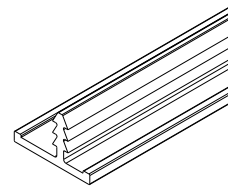

### 2mm Flush Edge For 18mm board

aluminium anodized

Cat No ■	Length (mm)	Finish
4268.39.018	2500*	black
4268.38.018	2500*	clear
4268.38.018.30	3000	clear

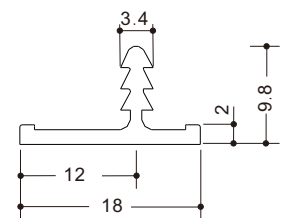
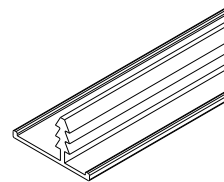

Dimensional Data not binding.  
We reserve the right to alter  
specifications without notice.

# 19mm Aluminium Frame Door Profile

## Glass Door Frame

silver colour, anodized  
use 4mm glass only

Cat No ■	Length(mm)
8202.38.045	2400*

Packing: 6pcs per carton \* Usable length 3030~3070mm

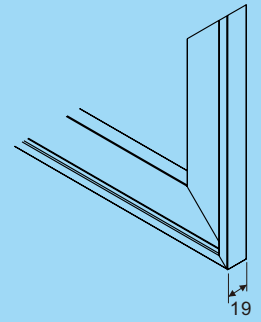
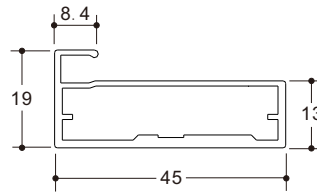
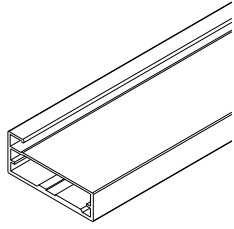

## Glass Door Frame

with handle, use to up-flap door  
suit to 8202.38.045

silver colour, anodized  
use 4mm glass only

Cat No ■	Length(mm)
8202.38.069	3100*

Packing: 6pcs per carton \* Usable length 3030~3070mm

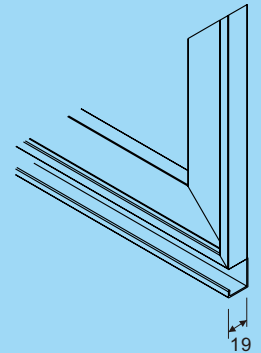
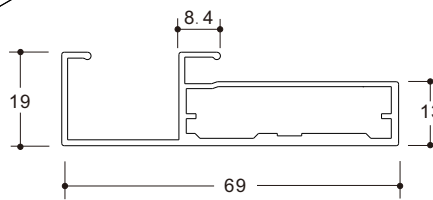
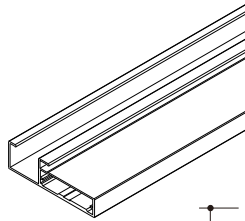

## Sealing Strip

plastic for glass

Cat No ■	8202.80.002
----------	-------------

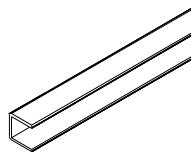

## Fixing Plate

steel, zinc-plated

Cat No ■	8200.57.001
----------	-------------

## Fixing Method:

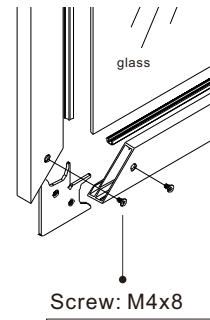
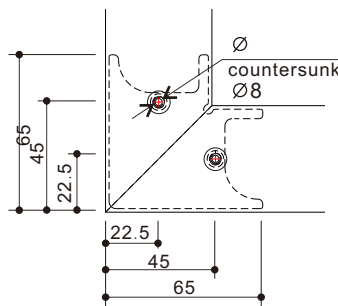
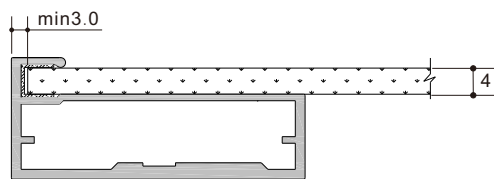

Cat No ■	8200.57.003
----------	-------------

Note: glass edge needs to be chamfered

## Flap Hinge Mounting Block

nylon, black

Cat No ■	8202.80.003
----------	-------------

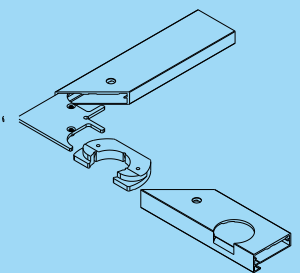
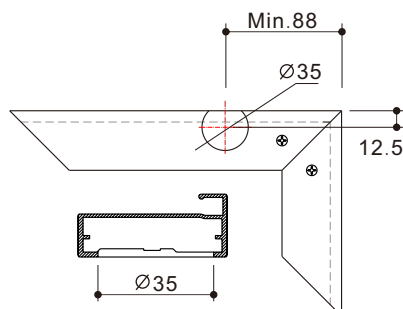
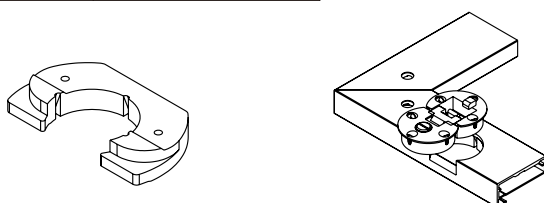

Dimensional Data not binding.  
We reserve the right to alter specifications without notice.

# Wardrobe Fittings

## Oval Wardrobe Rail

aluminium, silver colour, anodized

Cat No ■	Length (mm)
8101.38.015	3100*

\* Usable length 3030~3070mm

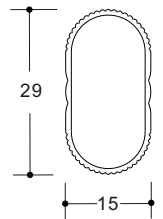
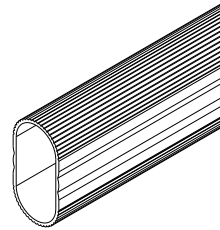

## Wardrobe Rail Support

zinc alloy, nickel-plated

Cat No ■	8101.46.001
----------	-------------

Packing: 1 and 50 pieces

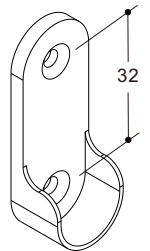

## Wardrobe Rail Centre Support

zinc alloy, nickel-plated

Cat No ■	8101.46.002
----------	-------------

Packing: 1 and 50 pieces

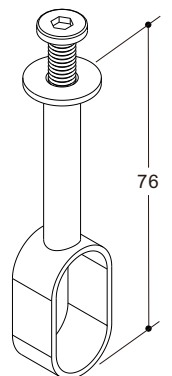



## CD/DVD Racks For Drawers

### CD Rack

aluminium, silver colour, anodized

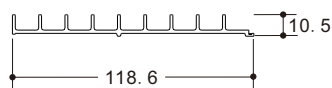
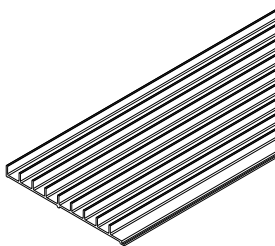

Cat No ■	Length (mm)
8108.38.118	2500*

Packing: 4pcs per carton

### DVD Rack

aluminium, silver colour, anodized

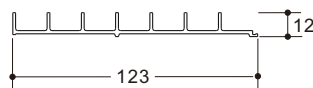
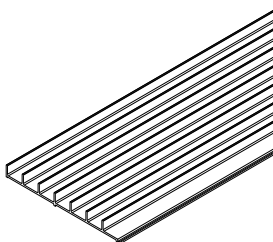

Cat No ■	Length (mm)
8109.38.123	2500*

Packing: 4pcs per carton

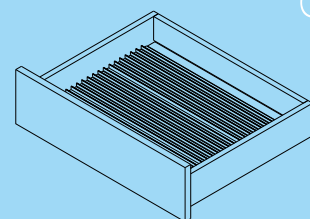
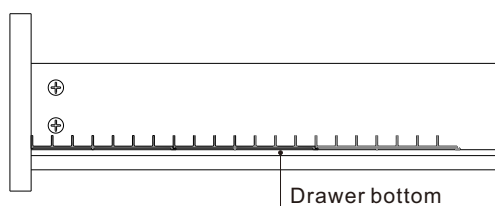
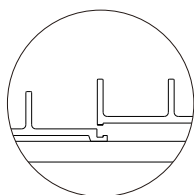

Dimensional Data not binding.  
We reserve the right to alter specifications without notice.

\* Usable length 2430~2470mm

## **SOLU HARDWARE**

Tel: (02)9139 6727 Mobile: 0417 668 684

[www.soluhardware.com.au](http://www.soluhardware.com.au) E-mail : [sales@soluhardware.com.au](mailto:sales@soluhardware.com.au)